

## FEATURES

- Output voltage up to 15.9 V<sub>pp</sub>
- Linear amplifier
- Flat gain up to 10 GHz
- Single voltage power supply
- Low group delay variation

## APPLICATIONS

- Radio Over Fiber
- Frequency-comb
- Spectrum broadening

## OPTIONS

- Heat-sink

## RELATED EQUIPMENTS

- MXIQER, MXAN, phase modulators

The DR-AN-10-HO is a wideband RF amplifier module designed for analog applications at frequencies up to 10 GHz.

The DR-AN-10-HO is characterized by a low Noise Figure and a linear transfer function whose 1 dB compression point is above 25 dBm. It exhibits flat Group Delay and Gain curves with reduced ripple over the entire bandwidth.

The DR-AN-10-HO operates from a single power supply for safety and ease of use, and offers gain control over 3 dB. It comes in a compact 52 mm x 25.6 mm housing with K type RF connectors (compatible SMA) and with an optional heat-sink.

This amplifier module is ideally suited to drive optical modulators for analog and linear applications.

## Performance Highlights

Parameter	Min	Typ	Max	Unit
Cut-off frequencies	80 k	11 G	-	Hz
Output voltage	0	-	15.9	V <sub>pp</sub>
Gain	-	27	-	dB
Saturated output power	27	28	-	dBm
Output power 1dB comp	25	26	-	dBm
Harmonics	-	-	-15	dBc
Noise figure	-	-	3	dB

Measurements for V<sub>bias</sub> = 12 V, V<sub>amp</sub> = 1.5 V, I<sub>bias</sub> = 520 mA

## DC Electrical Characteristics

Parameter	Symbol	Min	Typ	Max	Unit
Supply voltage (fixed)	$V_{bias}$	11	12	13	V
Current consumption	$I_{bias}$	-	520	580	mA
Gain control voltage	$V_{amp}$	-	1.5	2	V

## Electrical Characteristics

Parameter	Symbol	Condition	Min	Typ	Max	Unit
Lower frequency	$f_{3dB}$ lower	-3 dB point	-	-	80	kHz
Upper frequency	$f_{3dB}$ upper	-3 dB point	10	11	-	GHz
Gain	$S_{21}$	Small signal	25	27	-	dB
Gain ripple	-	< 10 GHz	-	-	$\pm 1.5$	dB
Input return loss	$S_{11}$	$f < 10$ GHz	-	-	-10	dB
Output return loss	$S_{22}$	$f < 10$ GHz	-	-	-10	dB
Isolation	$S_{12}$	$f < 10$ GHz	-	-	-60	dB
Output power 1 dB	$P_{1dB}$	$2 \text{ GHz} < f < 10 \text{ GHz}$	25	26	-	dBm
Saturated power	$P_{sat}$	$2 \text{ GHz} < f < 10 \text{ GHz}$	27	28	-	dBm
Output voltage	$V_{out}$	Linear	0	-	10	$V_{pp}$
		Maximum swing	0	-	15.9	
Noise figure	NF	$3 \text{ GHz} < f < 10 \text{ GHz}$	-	-	3	dB
Harmonics	Harm	$P_{1dB}$ , $f = 5 \text{ GHz}$	-	-	-15	dBc
Power dissipation	P	Small signal	-	6.2	-	W

Conditions: S parameters -30 dBm,  $T_{amb} = 25^\circ\text{C}$ , 50  $\Omega$  system

## Absolute Maximum Ratings

Stresses in excess of the absolute maximum ratings can cause permanent damage to the device. These are absolute stress ratings only. Functional operation of the device is not implied at these or any other conditions in excess of those given in the operational sections of the data sheet. Exposure to absolute maximum ratings for extended periods can adversely affect device reliability.

Parameter	Symbol	Min	Max	Unit
RF input voltage	$V_{in}$	-	0.9	$V_{pp}$
Supply Voltage	$V_{bias}$	11	13	V
DC current	$I_{bias}$	-	580	mA
Gain control voltage	$V_{amp}$	0	2	V
Power dissipation	$P_{diss}$	-	7.5	W
Temperature of operation	$T_{op}$	0	+40	$^\circ\text{C}$
Storage temperature	$T_{st}$	10	+70	$^\circ\text{C}$

**S<sub>21</sub> Parameter Curve**

Conditions:  $V_{bias} = 12\text{ V}$ ,  $V_{amp} = 1.5\text{ V}$ ,  $I_{bias} = 520\text{ mA}$

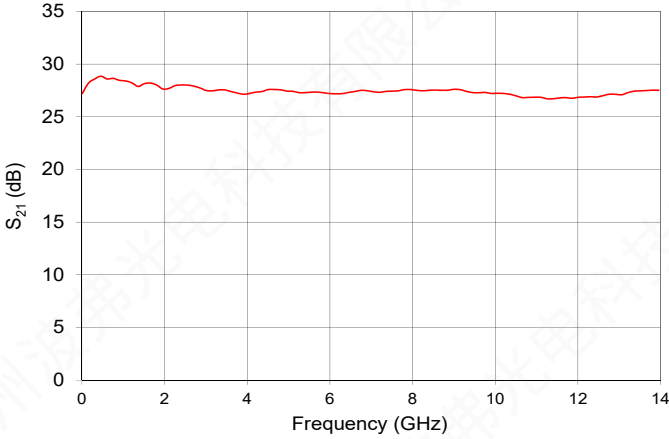

**Group Delay Parameter Curve**

Conditions:  $V_{bias} = 12\text{ V}$ ,  $V_{amp} = 1.5\text{ V}$ ,  $I_{bias} = 520\text{ mA}$

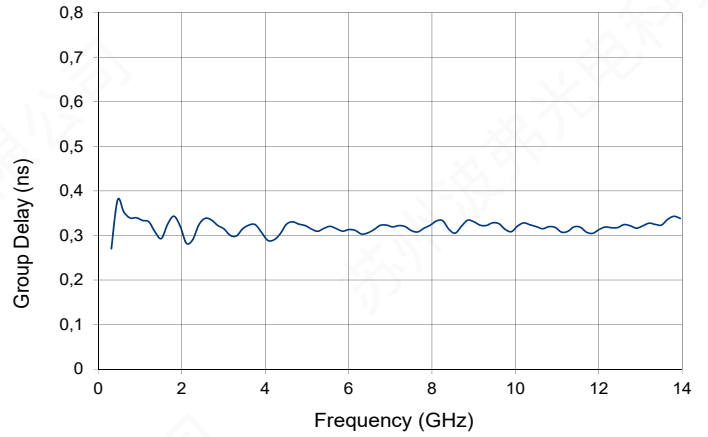

**S<sub>22</sub> Parameter Curve**

Conditions:  $V_{bias} = 12\text{ V}$ ,  $V_{amp} = 1.5\text{ V}$ ,  $I_{bias} = 520\text{ mA}$

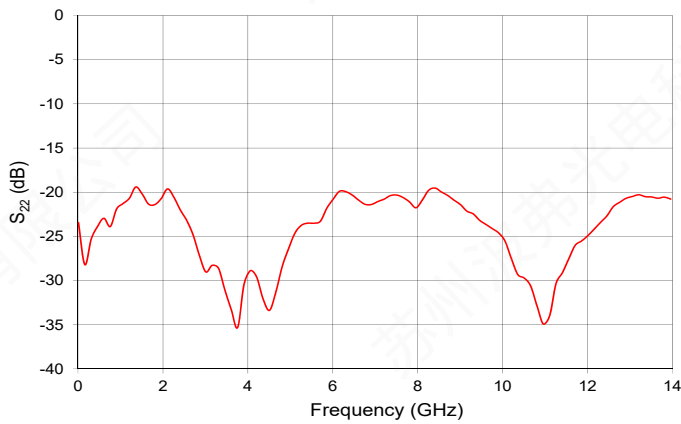

**S<sub>11</sub> Parameter Curve**

Conditions:  $V_{bias} = 12\text{ V}$ ,  $V_{amp} = 1.5\text{ V}$ ,  $I_{bias} = 520\text{ mA}$

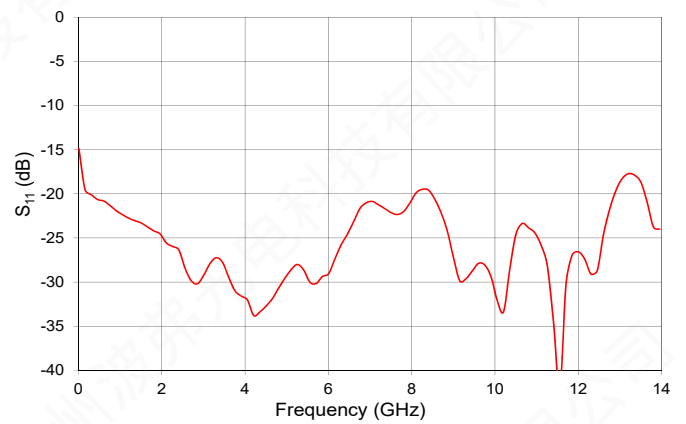

**P<sub>out</sub> @ 1dB compression Curve**

Conditions:  $V_{bias} = 12\text{ V}$ ,  $V_{amp} = 1.5\text{ V}$ ,  $I_{bias} = 520\text{ mA}$

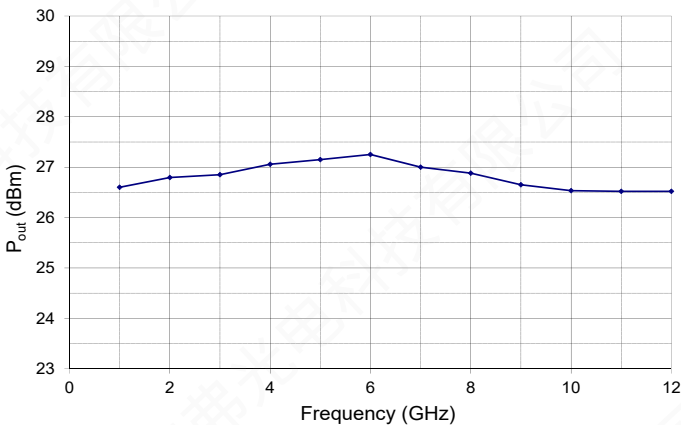

**Noise Figure Curve**

Conditions:  $V_{bias} = 12\text{ V}$ ,  $V_{amp} = 1.5\text{ V}$ ,  $I_{bias} = 520\text{ mA}$

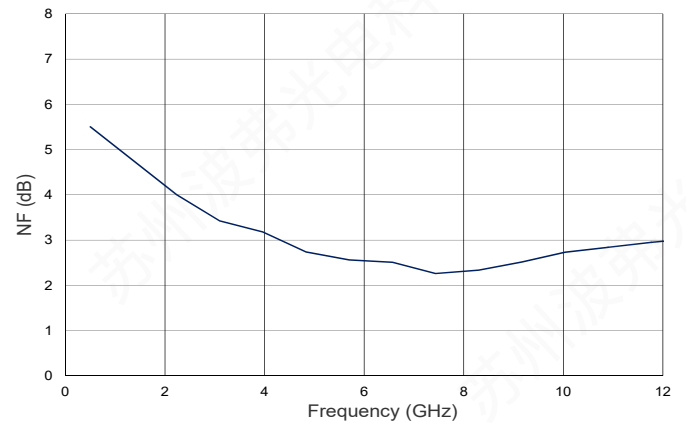

Electrical Schematic Diagram

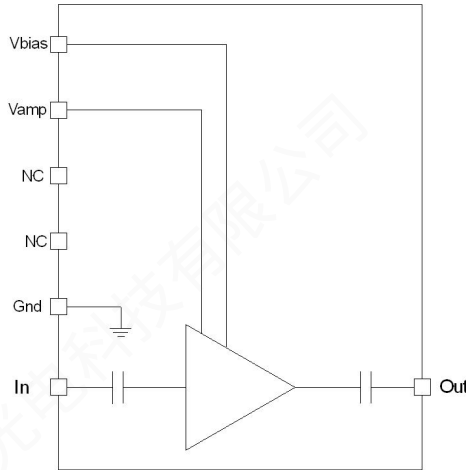

Mechanical Diagram and Pinout

All measurements in mm

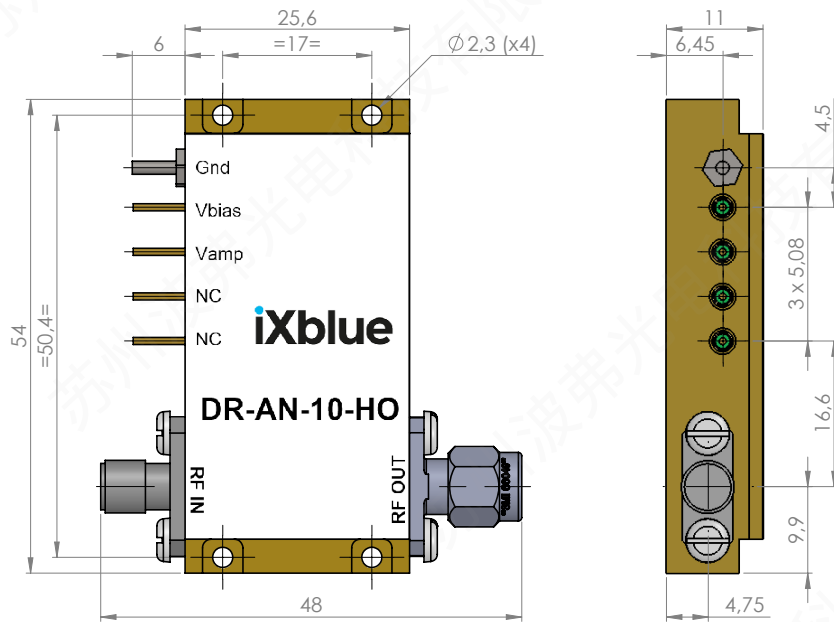

The heat-sinking of the module is necessary. It's user responsibility to use an adequate heat-sink. Refer to page 5 for ixblue recommended heat-sink.

PIN	Function	Unit
IN	RF In	Kconnector female
OUT	RF Out	K connector male
$V_{bias}$	Power supply voltage	Set a typical operating specification
$V_{amp}$	Output voltage amplitude adjustment	Adjust for gain control tuning

Mechanical Diagram And Pinout With HS-HO1 Heat-sink

All measurements in mm

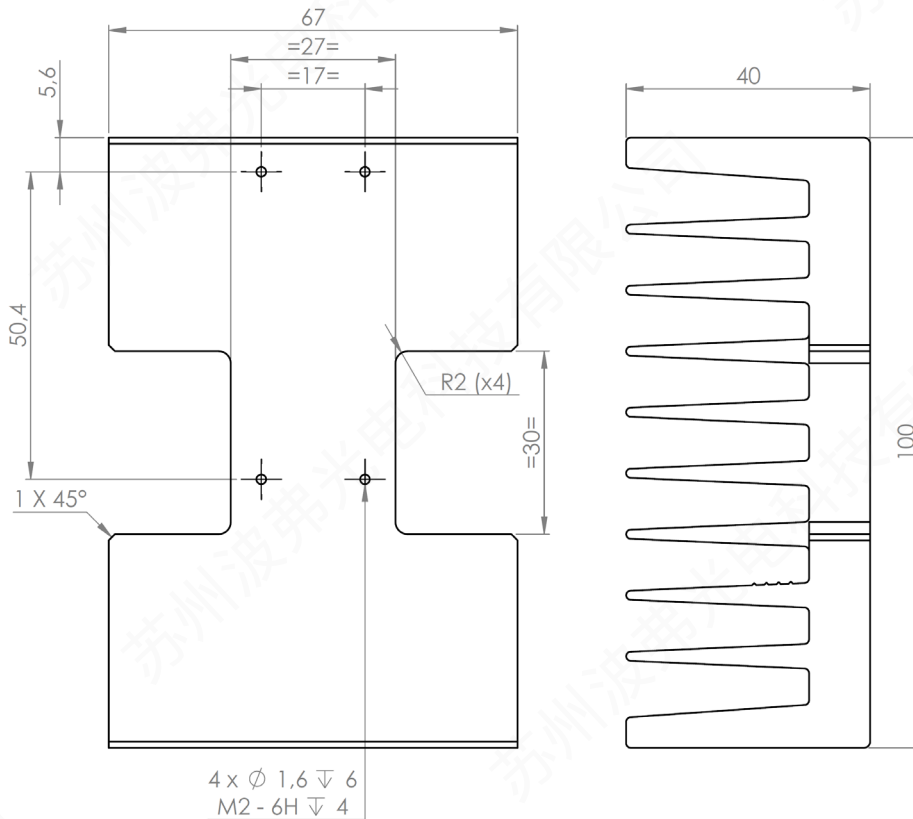
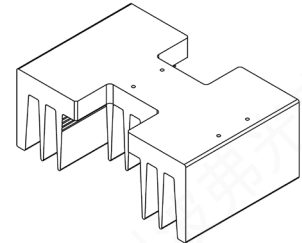

About us

ixblue Photonics produces specialty optical fibers and Bragg gratings based fiber optics components and provides optical modulation solutions based on the company lithium niobate (LiNbO<sub>3</sub>) modulators and RF electronic modules.

ixblue Photonics serves a wide range of industries: sensing and instruments, defense, telecommunications, space and fiber lasers as well as research laboratories all over the world.

3, rue Sophie Germain  
25 000 Besançon - FRANCE  
Tel. : +33 (0)1 30 08 87 43

ixblue reserves the right to change, at any time and without notice, the specifications, design, function or form of its products described herein. All statements, specification, technical information related to the products herein are given in good faith and based upon information believed to be reliable and accurate at the moment of printing. However the accuracy and completeness thereof is not guaranteed. No liability is assumed for any inaccuracies and as a result of use of the products. The user must validate all parameters for each application before use and he assumes all risks in connection with the use of the products