



FEATURES

- Superior extinction ratio: 40 dB
- High bandwidth
- X-cut for high stability
- Low drive voltage
- Low insertion loss

APPLICATIONS

- Pulse generation / picking
- Carrier suppression
- Fiber optics sensors
- Pulse applications

OPTIONS

- 20 GHz version
- 1060 nm, 1300 nm band versions

RELATED EQUIPMENTS

- Pulsed driver DR-PL
- MBC Automatic Bias Controllers

The MXER-LN series of intensity modulators is a family of high performance modulators exhibiting superior Extinction Ratio. Their specific design relies on ixblue "Magic Junction" (patent n° US2008193077).

MXER-LN series intensity modulators are key devices in all applications where a combination of high extinction and high bandwidth is required: laser pulse picking prior optical amplification, pulse generation or lidar based sensing systems are a few examples, as well as fiber optics sensors.

MXER-LN-10 Performance Highlights

Parameter	Min	Typ	Max	Unit
Operating wavelength	1530	-	1625	nm
Insertion loss	-	3,5	-	dB
Extinction ratio	-	30, 35, 40	-	dB
Electro-optical bandwidth	10	-	-	GHz

Specifications given at 25 °C, 1550 nm

MXER-LN-20 Performance Highlights

Parameter	Min	Typ	Max	Unit
Operating wavelength	1530	-	1625	nm
Insertion loss	-	3,5	-	dB
Extinction ratio	-	30, 35, 40	-	dB
Electro-optical bandwidth	18	-	-	GHz

Specifications given at 25 °C, 1550 nm

Extinction Ratio Response

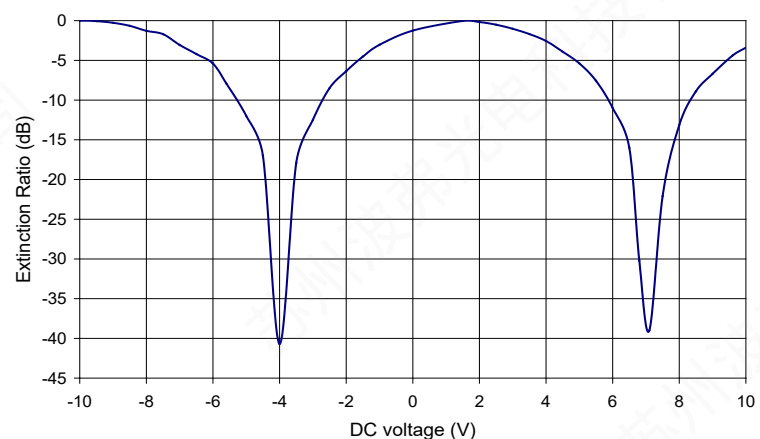

MXER-LN-10

10 GHz Very High Extinction Ratio Intensity Modulator

Electrical Characteristics

Parameter	Symbol	Condition	Min	Typ	Max	Unit
Electro-optic bandwidth	S_{21}	RF electrodes, from 2 GHz	10	12	-	GHz
Rise / fall times	t_r / t_f	Optical pulse, using DR-PL-10-MO	-	30	35	ps
Ripple S_{21}	ΔS_{21}	RF electrodes, $f < 12$ GHz	-	0.5	1	dB
Electrical return loss	S_{11}	RF electrodes, 0 - 12 GHz	-	-12	-10	dB
$V\pi$ RF @ 50 kHz	$V\pi_{RF 50 kHz}$	RF electrodes, @1550 nm	-	5.5	6	V
$V\pi$ RF @ 10 GHz	$V\pi_{RF 10 GHz}$	RF electrodes, @1550 nm	-	6.5	7	V
$V\pi$ DC electrodes	$V\pi_{DC}$	DC electrodes	-	6.5	7	V
Impedance matching	Z_{in-RF}	-	-	50	-	Ω
DC input impedance	Z_{in-DC}	-	1	-	-	M Ω

Optical Characteristics

Parameter	Symbol	Condition	Min	Typ	Max	Unit
Crystal	-	-	Lithium Niobate X-Cut Y-Prop			
Operating wavelength	λ	-	1530	1550	1625	nm
Insertion loss	IL	Without connectors	-	3,5	5	dB
DC extinction ratio	ER > 30	Measured at 1550 nm by default, for other λ contact us	30	-	-	dB
	ER > 35		35	-	-	dB
	ER > 40		40	-	-	dB
Optical return loss	ORL	-	-40	-45	-40	dB
Chirp	α	-	-0.1	0	-0.1	-

All specifications given at 25°C, 1550 nm, unless differently specified

Absolute Maximum Ratings

Stresses in excess of the absolute maximum ratings can cause permanent damage to the device. These are absolute stress ratings only. Functional operation of the device is not implied at these or any other conditions in excess of those given in the operational sections of the data sheet. Exposure to absolute maximum ratings for extended periods can adversely affect device reliability.

Parameter	Symbol	Min	Max	Unit
RF input power	EP_{in}	-	28	dBm
Bias voltage	V_{bias}	-20	+20	V
Optical input power	OP_{in}	-	20	dBm
Operating temperature	OT	0	+70	°C
Storage temperature	ST	-40	+85	°C

MXER-LN-20

20 GHz Very High Extinction Ratio Intensity Modulator

Electrical Characteristics

Parameter	Symbol	Condition	Min	Typ	Max	Unit
Electro-optic bandwidth	S_{21}	RF electrodes, from 2 GHz	18	20	-	GHz
Rise / fall times	t_r / t_f	Optical pulse with DR-PL-20-MO	-	20	25	ps
Ripple S_{21}	ΔS_{21}	RF electrodes, $f < 18$ GHz	-	0.5	1	dB
Electrical return loss	S_{11}	RF electrodes, 0 - 18 GHz	-	-12	-10	dB
$V\pi$ RF @ 50 kHz	$V\pi_{RF 50kHz}$	RF electrodes, @1550 nm	-	5.5	6	V
$V\pi$ DC electrodes	$V\pi_{DC}$	DC electrodes	-	6.5	7	V
Impedance matching	Z_{in-RF}	-	-	50	-	Ω
DC input impedance	Z_{in-DC}	-	1	-	-	M Ω

Optical Characteristics

Parameter	Symbol	Condition	Min	Typ	Max	Unit
Crystal	-	-	Lithium Niobate X-Cut Y-Prop			
Operating wavelength	λ	-	1530	1550	1625	nm
Insertion loss	IL	Without connectors	-	3,5	5	dB
DC extinction ratio	ER > 30	Measured at 1550 nm by default, for other λ contact us	30	-	-	dB
	ER > 35		35	-	-	dB
	ER > 40		40	-	-	dB
Optical return loss	ORL	-	-40	-45	-40	dB
Chirp	α	-	-0.1	0	-0.1	-

All specifications given at 25°C, 1550 nm, unless differently specified

Absolute Maximum Ratings

Stresses in excess of the absolute maximum ratings can cause permanent damage to the device. These are absolute stress ratings only. Functional operation of the device is not implied at these or any other conditions in excess of those given in the operational sections of the data sheet. Exposure to absolute maximum ratings for extended periods can adversely affect device reliability.

Parameter	Symbol	Min	Max	Unit
RF input power	EP_{in}	-	28	dBm
Bias voltage	V_{bias}	-20	+20	V
Optical input power	OP_{in}	-	20	dBm
Operating temperature	OT	0	+70	°C
Storage temperature	ST	-40	+85	°C

Typical S_{21} Curve

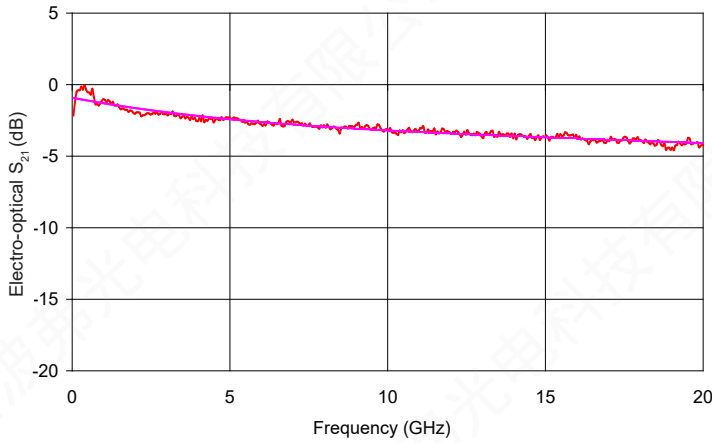

Typical S_{11} Curve

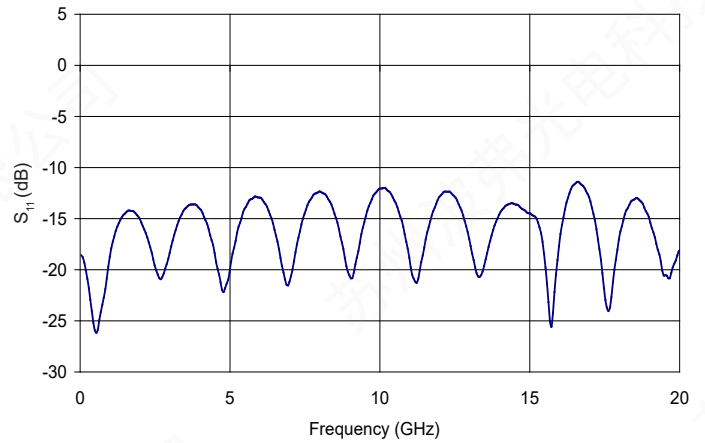

Extinction Ratio

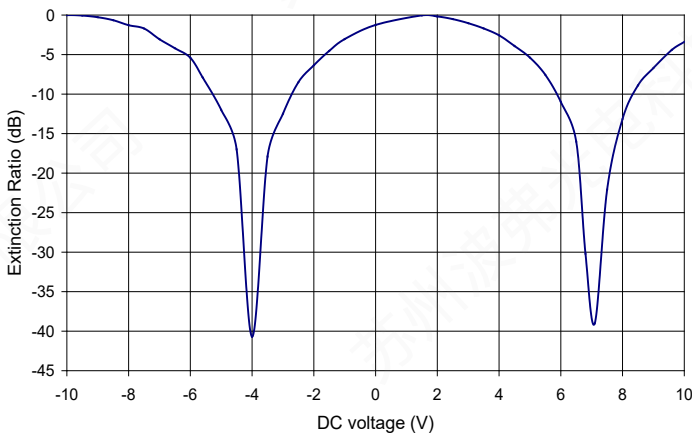

Generated 80 ps Optical Pulse

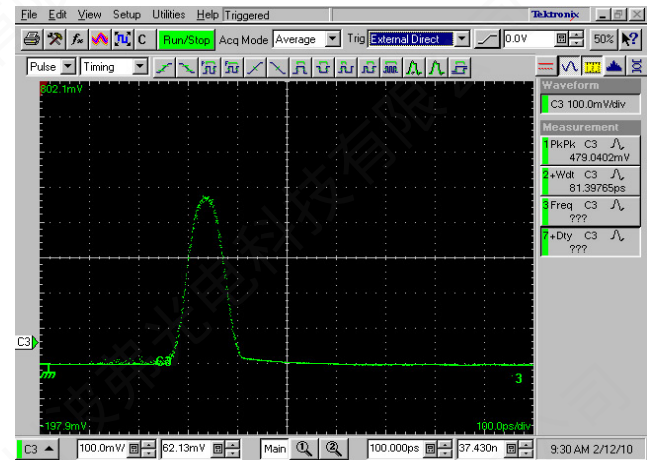

Stability with Time and Temperature

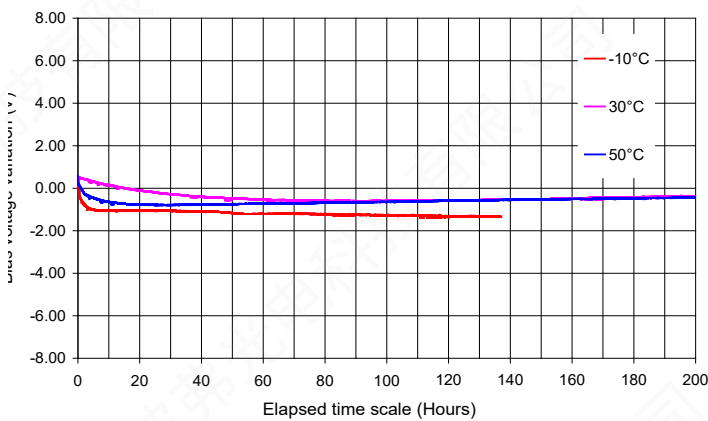

Insertion Loss with Time and Temperature

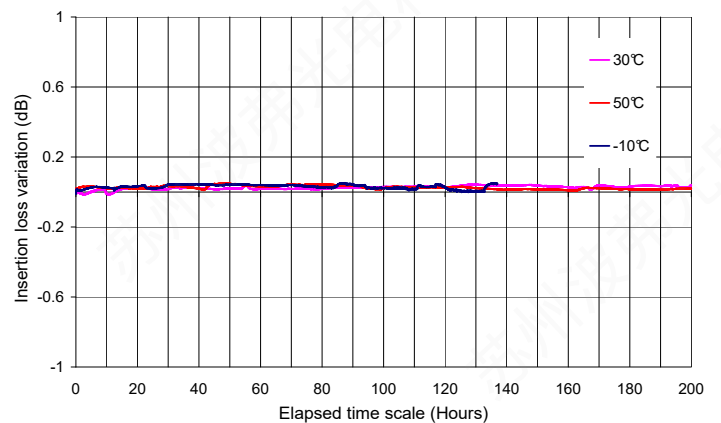

Mechanical Diagram and Pinout

All measurements in mm

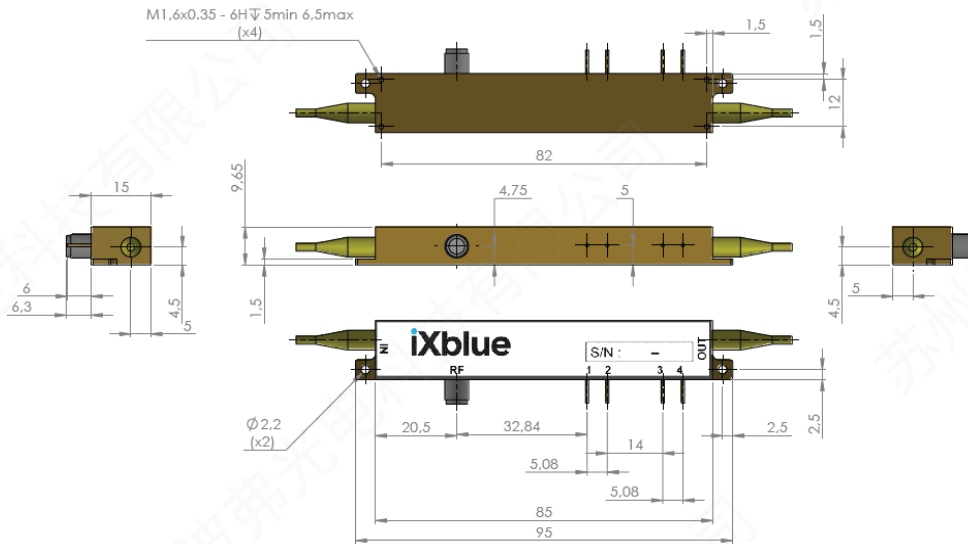

Port	Function	Note
IN	Optical input port	Polarization maintaining fiber, Corning PM 15-U25D, Length 1.5 meter. Buffer diameter 900 mm
OUT	Optical output port	Polarization maintaining fiber, Corning PM 15-U25D, Length 1.5 meter. Buffer diameter 900 mm
RF	RF input port	Female K (SMA compatible)
1	Ground	Pin feed through diameter 1.0 mm
2	DC	Pin feed through diameter 1.0 mm
3, 4	Photodiode cathode, anode	Pin feed through diameter 1.0 mm

Ordering information

MXER-LN-BW-XX-Y-Z-AB-CD-xxdB

BW = Bandwidth : 10 10 GHz 20 20 GHz
 XX = Internal photodiode PD, 00 : Not integrated PD : Integrated
 Y = Input fiber : P Polarization maintaining S Standard single mode
 Z = Output fiber : P Polarization maintaining S Standard single mode
 AB = Input connector : 00 bare fiber FA FC/APC FC FC/SPC
 CD = Output connector : 00 bare fiber FA FC/APC FC FC/SPC
 xxdB = Extinction ratio : 30 30 dB - 35 35dB - 40 40dB
 Note : optical connectors are Senko with narrow key or equivalent

About us

ixblue Photonics produces specialty optical fibers and Bragg gratings based fiber optics components and provides optical modulation solutions based on the company lithium niobate (LiNbO₃) modulators and RF electronic modules.

ixblue Photonics serves a wide range of industries: sensing and instruments, defense, telecommunications, space and fiber lasers as well as research laboratories all over the world.

3, rue Sophie Germain
 25 000 Besançon - FRANCE
 Tel. : +33 (0)1 30 08 87 43

ixblue reserves the right to change, at any time and without notice, the specifications, design, function or form of its products described herein. All statements, specification, technical information related to the products herein are given in good faith and based upon information believed to be reliable and accurate at the moment of printing. However the accuracy and completeness thereof is not guaranteed. No liability is assumed for any inaccuracies and as a result of use of the products. The user must validate all parameters for each application before use and he assumes all risks in connection with the use of the products